



User manual

For electrical appliances with a DRU Bluetooth remote control

Store this document in a safe place



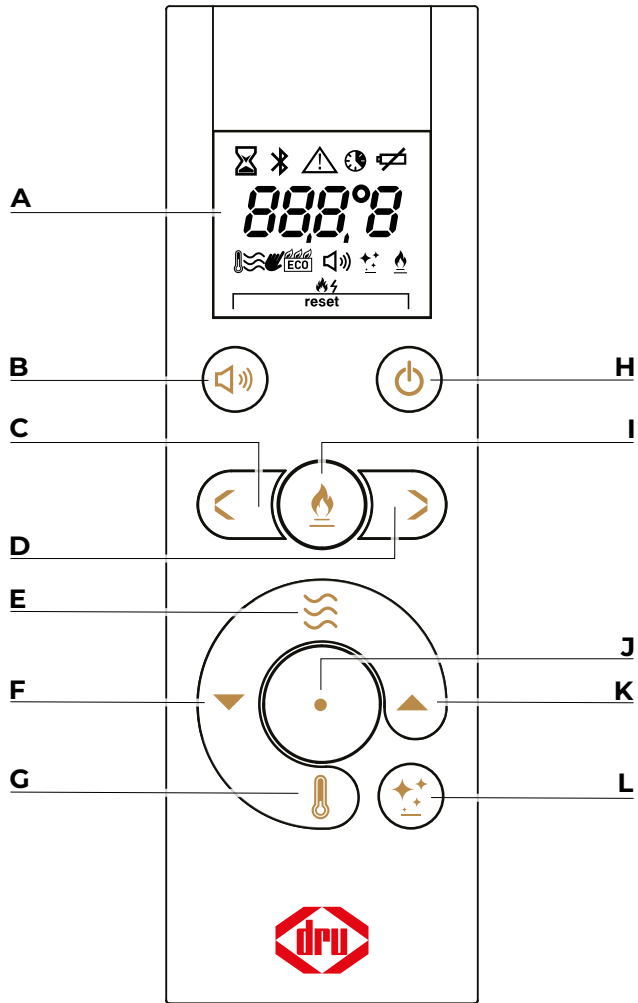



























3BC-2829

- A** - Display
- B** - Sound
- C** - Previous
- D** - Next
- E** - Heating
- F** - Temp. lower

- G** - Thermostat
- H** - On/Off
- I** - No function
- J** - Function button
- K** - Temp. higher
- L** - Glow

Button	Display	Description
		Switching the appliance on and off Page 16, section 5.1
		Sound on/ off Page 16, section 5.5
		Switching on heating Page 17, section 5.6
		Switching on the thermostat Page 18, section 5.7
		Glow on/off Page 16, section 5.4
		Bluetooth pairing mode Page 13, section 4.1.2
		Temperature display The currently measured room temperature
		Connection lost Page 21, section 5.10
		Action in progress Een actie wordt uitgevoerd
		Bluetooth connection status Page 14, section 4.1.2
		Error message Page 22, chapter 6
		Time schedule on/off Page 19, section 5.8
		Replacing the batteries Page 12, section 4.1.1
		Firmware update remote control Page 21, section 5.10
		Signal strength Page 23, section 6.2
		Resetting the appliance Page 24, section 6.3
		Disconnecting Page 16, section 5.1
		Celsius/ Fahrenheit Switch Page 20, section 5.9
		Pairing the remote control Page 14, section 4.1.2

Inhoud





1. Introduction	5
2. Safety	6
2.1 Precautions / safety instructions	6
2.1.1 Safety of the installation	6
2.1.2 Safety of people and animals	7
2.1.3 Safety through maintenance	8
2.2 EU Declaration of Conformity	9
3. Taking the appliance in operation	10
3.1 First use	10
3.2 Protection	10
3.3 Main switch	11
4. Operating the remote and DruFire App	12
4.1 Preparing the remote control for use	12
4.1.1 Placing/replacing the batteries 	12
4.1.2 Pairing the remote control	14
4.1.3 Disconnecting the remote control	14
4.2 DRU Fire App	15
4.2.1 Pairing the DRU Fire App	15
5. Operating the appliance	16
5.1 Switching off the appliance 	16
5.2 Switching on the appliance 	16
5.3 Selectin the flame picture	16
5.4 Switching the glow on/off 	16
5.5 Switching the sound on/off 	16
5.6 Manual operation of the heating 	17
5.7 Thermostat 	18
5.8 Time schedule 	19
5.9 Temperature display in Celsius or Fahrenheit	20
5.10 Updating the remote control	21
6. Malfunction	22
6.1 Error message 	22
6.2 Measuring the strength of the signal	23
6.3 Factory reset	24
7. Maintenance	25
7.1 Cleaning the glass pane(s)	26
8. Environment	27
8.1 General	27
8.2 Appliance	27
9. Warranty	27
10. Technical data of the remote control	27

1. Introduction

DRU, a manufacturer of gas-fired and electric stoves, develops and produces products that comply with the highest quality, performance and safety requirements. This appliance has a CE label, which means that it complies with the essential requirements of the European directives. The appliance is supplied with an installation manual and a user manual. Installation and maintenance of the appliance must be carried out by a professional and certified expert with proven knowledge and competence, hereafter referred to as competent installer.

This user manual contains all information required to operate the appliance in a correct and safe manner. Carefully read this manual before taking the appliance in operation. Users are only permitted to perform the work described in the user manual. For other activities you must involve a competent installer. In case of questions or doubts, please contact your dealer.

The following symbols are used in the manual to indicate important information:



-  Work to be performed.
-  Suggestions and recommendations.
-  Necessary instructions to prevent problems that might occur during installation and/or use.
-  Necessary instructions to prevent fire, personal injury or other serious damages.







2. Safety

2.1 Precautions / safety instructions









- Carefully read this section about safety and accurately observe the measures and instructions in this manual.

2.1.1 Safety of the installation

-  The appliance is powered by 230VAC 50Hz.
-  Do not make any changes to the appliance.
-  In case of malfunctions and/or poor performance, remove the plug from the socket and contact your dealer.





-  Never use the appliance in case of a broken or cracked glass pane. Remove the plug from the socket and have the glass pane replaced.
-  Make sure that combustible objects and/or materials such as curtains have a distance from the appliance of at least 80 cm, unless indicated otherwise in the installation manual.
-  Do not dry clothes, towels, etc. on and/or near the appliance, in order to prevent fire.
-  Avoid contact with hot parts of the appliance to prevent burns.
-  If the plug or mains cord are damaged, these should be replaced immediately. Have this done by a qualified person.
-  In order to avoid overheating, do not cover the heater. Always keep the convection opening at the front of the appliance free so that warm air is able to circulate freely.
-  The appliance must not be located immediately below a socket-outlet.

2.1.2 Safety of people and animals

-  Do not leave children and persons who cannot judge the consequences of their actions alone with a appliance that is switched on.
-  Place the remote control out of reach from children and persons who cannot properly judge the consequences of their actions.
-  Only if supervised by an experienced person, or if instructions have been provided about how to operate the appliance and the accompanying safety risks, is it permitted to have the appliance operated by children from 8 years of age, persons with reduced physical, sensory or mental capacities and persons with lack of experience and knowledge.
-  Children should not play with the appliance.
-  Cleaning and user maintenance should not be performed by children without supervision.
-  The appliance may only be operated by means of the remote control and/or the DRU Fire App, if the appliance is supervised.
-  In case of operation by means of the thermostat function or the DRU Fire App, the appliance may be switched on without a direct command having been given. Take measures to prevent damage and unsafe situations in such cases.
-  If the DRU Fire App is used, measures should be taken to avoid hacking and thus unintended activation of the appliance.

 The appliance was designed for atmospheric and heating purposes. This means that all visible surfaces, including the glass pane, can become hotter than 100°C. It is recommended to always place a guard grille in front of the appliance when children, older people or persons with reduced physical, sensory or mental capacities are in the same room as the appliance. If these vulnerable people are regularly present in the room without supervision, a fixed guard should be made around the appliance.

2.1.3 Safety through maintenance

-  The appliance should be installed by a competent installer.
-  Your appliance should be maintained at least once per year by a competent installer.
-  Allow the glass pane(s) to cool down to room temperature prior to cleaning.
-  Contact your dealer for the safe and correct removal of the appliance.

2.2 EU Declaration of Conformity

We, DRU Verwarming B.V. hereby declare that the type of radio equipment 'Remote Control DRU RC BLE' is in conformity with directive 2014/53/EU.

The complete text of the EU Declaration of Conformity can be consulted at the following internet address:
druservice.com

3. Taking the appliance in operation

3.1 First use

- ⚠ If the chimney breast is made of stone-like materials or has been finished in stucco, it should be left to dry for at least 6 weeks before using the heater to prevent shrinkage cracks.

3.2 Protection

- ⚠ - To prevent unsafe situations, carefully observe the following measures and instructions.
 - Do not dry clothes, towels, etc. on and/or near the appliance, in order to prevent fire;
 - Avoid contact with hot parts of the appliance to prevent burns;
 - Do not leave children and persons who cannot judge the consequences of their actions alone with a heating appliance.
 - Place the remote control out of reach from children and persons who cannot properly judge the consequences of their actions.

3.3 Main switch

The appliance is provided with a main switch on the inside of the upper decorative strip (fig. 3-1). This main switch can be used to switch off the entire electrical system of the appliance.

- ⚠ - The main switch does not make the appliance fully free from voltage.
- Always remove the plug from the socket prior to cleaning and/or maintenance work inside the appliance.

- ⚠ Make sure the main switch is in the on position before using the fire.

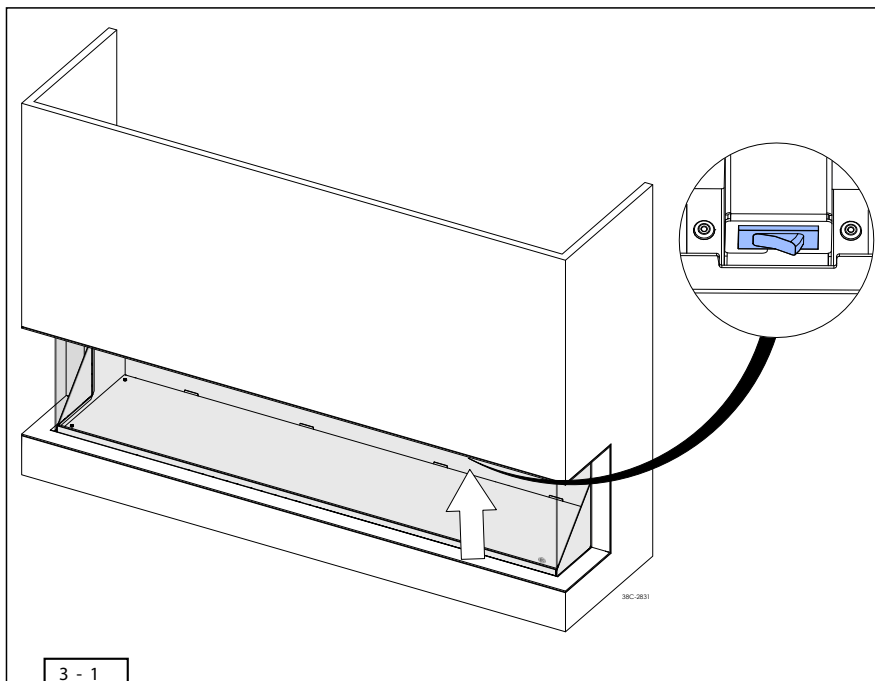

4. Operating the remote and Drufire App

Several methods can be used to operate the appliance.
These are described in the sections below.

4.1 Preparing the remote control for use

The appliance is supplied with a remote control. Its functions and possibilities are described in the following subsections.

- 💡 The  symbol on the display of the remote control shows the current status of the connection with the appliance:
 - Not visible: No connection with the appliance
 - Flashing: Looking for connection with the appliance
 - Visible: Connected with the appliance

4.1.1 Placing/replacing the batteries

The remote control works with two AA alkaline batteries.

When the  symbol lights up on the display, the batteries should be replaced.

- 💡
 - It is not possible to use rechargeable batteries.
 - If the batteries are completely empty, the display will go blank.
Replace the batteries of the remote control in time.
 - Timely replacement of the batteries also prevents possible damage to the electronic components due to leaking batteries.
- Remove the cover from the battery compartment by pushing it down lightly and sliding it off the remote control (fig. 4-1, 1).
- Remove the old batteries from the holder (fig. 4-1, 2).
- Place the new batteries in the holder (fig. 4-1, 2).
- 💡 The correct orientation of the batteries to be placed is shown on the inside of the battery compartment.
- Place back the cover, slide it upwards and allow it to snap tight to lock (fig. 4-1, 3).
- ⚠ Hand in the batteries at the collection point intended for this purpose.

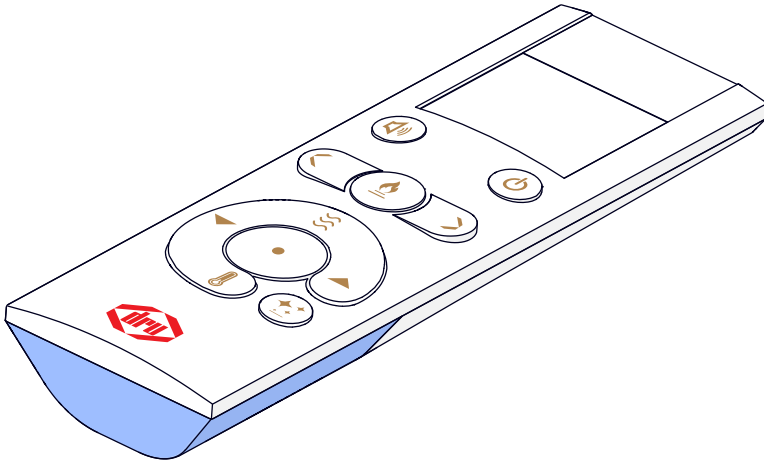

1

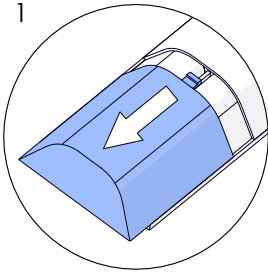

2

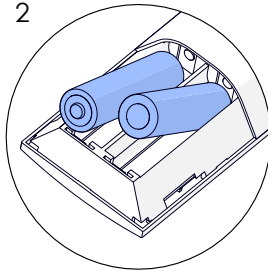

3

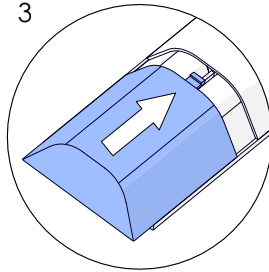





4 - 1

38C-2830

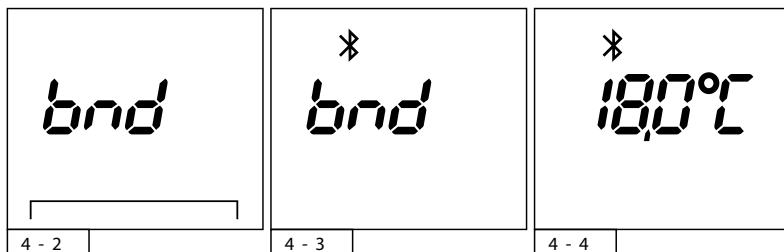
4.1.2 Pairing the remote control



Before you can use the appliance, it must be paired with the remote control. For this, proceed with the following steps:



- 💡 The remote control should be in *bnd* mode to be able to pair with the appliance (fig. 4-2). If this is not the case, see section 4.1.3 for instructions.
- Switch off the appliance and wait a few seconds.
- Switch on the appliance and wait for the sound signal.
- 💡 After switching on, it is possible to pair the remote control with the appliance for 5 minutes.
- Simultaneously press buttons  and . During pairing with the appliance, the  symbol flashes (fig. 4-3).
- When pairing has been successful, the  symbol lights up continuously and the current room temperature is shown. The remote control is now ready for use (fig. 4-4).

4.1.3 Disconnecting the remote control

Follow the steps below to disconnect the remote control from the appliance:

- First press the function button  immediately followed by the  button. Hold down both buttons for a few seconds until the *bnd* symbol is shown on the display (fig. 4-2). The remote control is now disconnected from the appliance.
- 💡 To reconnect the remote control, see section 4.1.2.

4.2 DRU Fire App

The free DRU Fire App allows you to operate the appliance via a smartphone or tablet.

The DRU Fire App is available for both iOS and Android devices.



4.2.1 Pairing the DRU Fire App

Follow the steps below to pair the DRU Fire App with the appliance:

- 💡 - The remote control must be paired with the appliance before the App can be paired with the appliance (section 4.2.2).
- For optimum functionality and safety, it is essential to always use the latest version of the Drufire App, and the same applies to the firmware of the appliance and remote control.
- Open the Drufire App and follow the step-by-step instructions for pairing the App with the appliance.
- 💡 - Switch on the appliance with a visible flame picture.
- Place the appliance in **PAIR** mode by pressing the ● button on the appliance for 5 seconds (fig. 4-5).

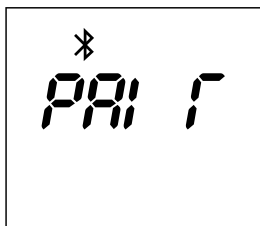

4 - 5

5. Operating the appliance

5.1 Switching off the appliance

The appliance can be switched off by pressing the  button.

The appliance will switch off immediately.

5.2 Switching on the appliance

Follow the step below to switch on the appliance.





Press the  button. The appliance will immediately start the start up cycle.



When the start up cycle has been completed, the  symbol is shown on the display.

5.3 Selectin the flame picture

By means of the  and  buttons, the next or previous flame picture can be selected.

5.4 Switching the glow on/off

Glow can be switched on and off by pressing the  button.

Changing colour, intensity and speed is only possible via the app.

5.5 Switching the sound on/off







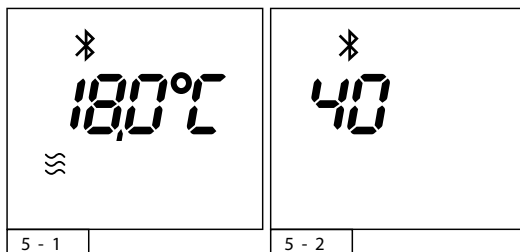

The sound can be switched on and off by pressing the  button.

5.6 Manual operation of the heating

The heating element can be manually operated in 2 positions.

Follow the steps below to adjust the heating:







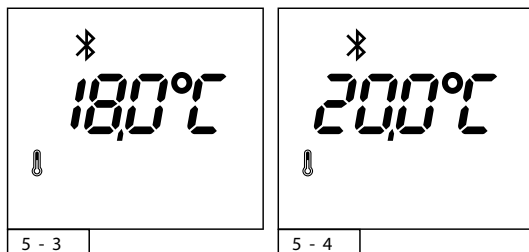

- Press the  button to switch on the appliance.
 - Press the  button to activate manual operation. The  symbol is shown on the display.
 - Use the  and  buttons to set the required position. Heating position 1 for half capacity or heating position 2 for full capacity. For a few seconds, the set position remains visible on the display (fig. 5-2), after which the remote control returns to the main screen (fig. 5-1).
 - The heating position can be adjusted at any time by repeating the steps described above.
 - The heating element can be switched off by pressing the  button once more. The  symbol is now no longer visible.
-  If a time schedule is active and the appliance is switched on manually, the appliance will change its settings according to the time schedule in the event of a scheduled switch in the time schedule.

5.7 Thermostat

By means of the thermostat function, the heating element is switched on based on the required room temperature.



- Switch on the thermostat by pressing the  button (fig. 5-3).
- Use the  and  buttons to select the required temperature.
- 💡 The temperature can be set between 5.0 and 35.0 °C.
- For a few seconds, the programmed temperature remains visible on the display (fig. 5-4).
- The remote control then returns to the main screen. The current room temperature is shown (fig. 5-3).
- The  symbol is shown on the display.

- ⚠ Make sure the remote control is in the same room as the appliance.
- 💡
 - The remote control contains a temperature sensor. Therefore, always place it on a fixed, draught-free location with no direct sunlight.
 - When the set temperature has been reached, the heating element is switched off.
- The thermostat function can be switched off by pressing the  button once more. The  symbol is no longer visible on the remote control's display.



- ⚠ The thermostat has a cycle of a couple of minutes. As a result, it may take longer before the thermostat function responds.

- ⚠ If a time schedule is active and the appliance is switched on manually, the appliance will change its settings according to the time schedule in the event of a scheduled switch in the time schedule.

5.8 Time schedule

The time schedule must be set by means of the DRU Fire App. If a time schedule is active, the  symbol is shown on the display of the remote control.

It is possible to switch the set time schedule on and off manually, by means of the remote control.

- First press the function button  immediately followed by the  button. When switching on, the  symbol is shown on the display and when switching off it will disappear (fig. 5-5 and 5-6).

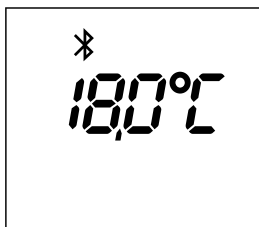

5 - 5

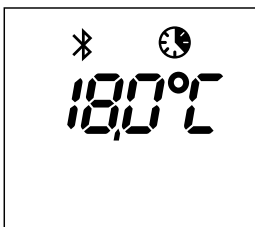

5 - 6

5.9 Temperature display in Celsius or Fahrenheit

The standard temperature display is in degrees Celsius. It is possible to change the temperature display between Celsius and Fahrenheit.

Follow the steps below to do this:

- First press the function button ● immediately followed by the 🌡 button. Hold down both buttons for 3 seconds.
- The display shows the currently selected temperature unit. Use the ▲ and ▼ buttons to select the required temperature unit (fig. 5-7 and 5-8).
- Wait 2 seconds or press the 🌡 button to confirm your selection.

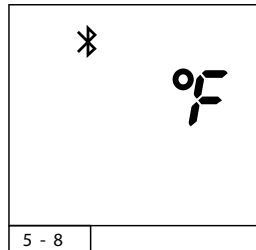
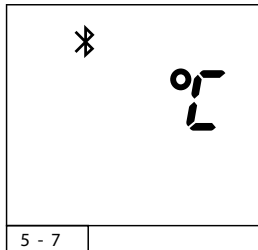

5.10 Updating the remote control

It is possible to provide the remote control with a software update, if such an update is available. To be able to perform this update, use of the DRU Fire App is required (section 4.1).

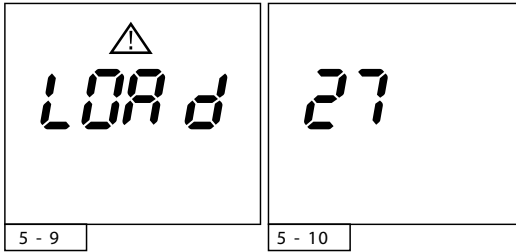

Proceed as follows to provide the remote control with an update:

- ⚠ Make sure the batteries in the remote control have sufficient power and are not removed during the update process.
- First press the function button ● immediately followed by the ✨ button. Hold down both buttons for 10 seconds.
- The display shows the message *LOAD* (fig. 5-9).
- Now, you are able to start the update process in the DRU Fire App. Observe the steps in the App.

- 💡 - If there is no activity within a period of 20 seconds, the remote control returns to the main screen.
- To find the version number of the software on the remote control, first remove the batteries from the remote control. When the batteries are placed back, the version number is shown on the display for 3 seconds (fig. 5-10).

6. Malfunction

6.1 Error message **LOS t**

The remote control has lost its connection with the appliance.

This could have several causes:

- The remote control is too far removed from the appliance.
Bring the remote control nearer to the appliance.
- The appliance is free from voltage.
Restore the voltage to the appliance.

If the signal is lost, the remote control will show an empty screen with an hourglass for the first 30 seconds (fig. 6-1). If the signal is lost for more than 30 seconds, the error message **LOS t** will appear and the Bluetooth symbol  will flash on the display (fig. 6-2).



During the above-mentioned message, the remote control continues to search for the appliance and the connection is restored when the appliance and remote control are within each other's reach again.

If the signal is lost for more than 1 minute, the remote control will stop searching for the appliance (fig. 6-3).



When a random button is pressed, the remote control will try to restore the connection between the appliance and the remote control for 1 minute.

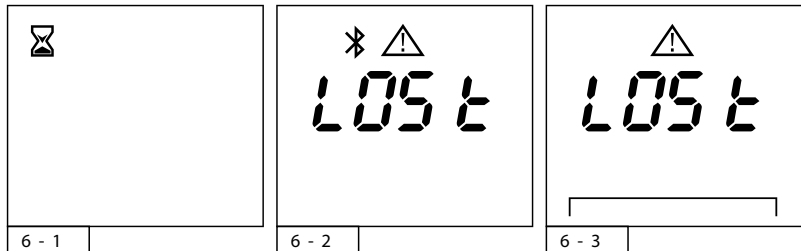

6.2 Measuring the strength of the signal

It is possible to measure the received signal strength from the appliance on the remote control. A good signal strength is between -20dB and -70dB , a poor signal strength is below -70dB . Proceed as follows to check the signal strength:

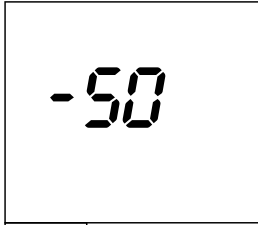







6 - 4

- First press the function button ● immediately followed by the  button. Hold down both buttons for 5 seconds.
- The display shows the currently measured signal strength. (fig. 6-4)
- 💡 After 10 seconds, the display automatically returns to the main screen. Each press on the button extends this function by 10 seconds.

6.3 Factory reset

If the appliance repeatedly enters into a fault or is unable to get out of a fault, it is possible to perform a factory reset.

-  In case of a fault, always first observe the steps in section 3.3 in order to perform a factory reset.
-  Contact your dealer if faults occur repeatedly and/or return.
-  In case of a factory reset, all your preferred settings and flame pictures will be removed. These can be set once more after the reset.
-  First press the function button ● immediately followed by the  button. Hold down both buttons for 10 seconds to perform a factory reset.
-  Remove the appliance from the Bluetooth settings of each coupled smart device and connect them again as described in section 4.3.2.

7. Maintenance

At least once per year, the appliance should be checked for proper and safe operation.



- Your appliance should only be maintained by a competent installer.
- In case of a broken or torn glass pane, do not use the heating element. Have the glass pane replaced immediately.
- Do not make any changes to the appliance yourself.



- Do not use corrosive or abrasive detergents when cleaning.
- Unpainted stainless steel parts can be cleaned with water, a soft cloth and a mild detergent if necessary. Aggressive detergents (such as chlorinated or abrasive detergents) could lead to corrosion and/or dull spots.

7.1 Cleaning the glass pane(s)

For an optimum experience of the appliance, it is recommended to clean the glass pane.



The glass pane(s) to be cleaned should be cooled down to room temperature.



Avoid damage to the glass pane(s).



- Use a damp microfibre cloth. Other materials such as (kitchen) paper, steel wool, etc., could cause scratches.
- It is recommended to use a good quality glass cleaner as a detergent for the glass panes.
- Always wear the cotton gloves during the cleaning process to prevent the introduction of new fingerprints.

8. Environment

8.1 General

Packaging materials should be disposed of via the waste streams intended for that purpose.

- ⚠ Do not throw empty batteries away as residual waste, but hand them in at the collection point intended for that purpose.

8.2 Appliance

The appliance should be processed in a responsible method intended for that purpose.

- ⚠ Do not place the appliance with unsorted waste, but bring it to a collection point intended for that purpose.
- 💡 Contact your council for information about the available collection streams.

9. Warranty

The factory warranty is valid for 2 years after date of purchase.

Damages to the paint, resulting from objects fallen/placed on or against the appliance are not covered by the warranty.

The warranty for your DRU appliance will be provided via your dealer. Contact your dealer in case of questions and/or complaints.

10. Technical data of the remote control

Batteries: 2x AA (Rechargeable batteries not possible)

Transmission capacity: 0,1mW (-9.9 dBm)

Transmission frequency: 2402-2480 MHz

i am  since 1754

i am
everywhere



DRU Verwarming B.V.
PO Box 1021 | 6920 BA Duiven
Ratio 8 | 6921 RW Duiven
The Netherlands
+31 (0)26 - 319 5 319
www.drufire.com



BY APPOINTMENT OF
THE COURT OF THE NETHERLANDS



www.drufire.com

